

When positioning a user thoracic support can be used to improve the user's posture and balance, to give stability in sitting, and to prevent the user from leaning to the side.

Thoracic support can also be used as side support to Headrest Side+ and Neck rest Side+ to position the users head. This info sheet does not contain complete information about this.

Assessment of the user's needs and potential risks must be made in each case. Supplementation of the existing user manual may be necessary.

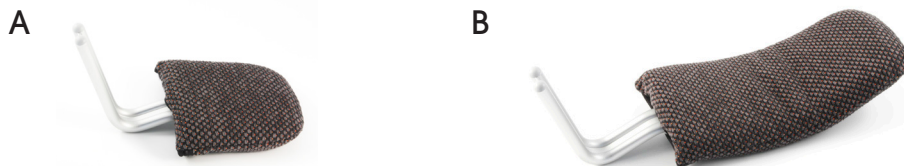

## Thoracic Support Standard

Thoracic Support Standard (A) is used when the user leans to the side. It can also be used in an effort to control a flexible spinal scoliosis or to prevent further deterioration.

## Thoracic Support Adjustable

Thoracic Support Adjustable (B) offers support for users who lean sideways and diagonally forward. It can also be used to distribute the pressure over a larger area of the trunk. The adjustable thoracic support is available with short or long pad. The short pad is used for small and medium-sized users and the long pad is used for medium and large users.

The pad of the Thoracic Support Adjustable can be set at an angle (C) and depth (D) using the supplied Allen keys.

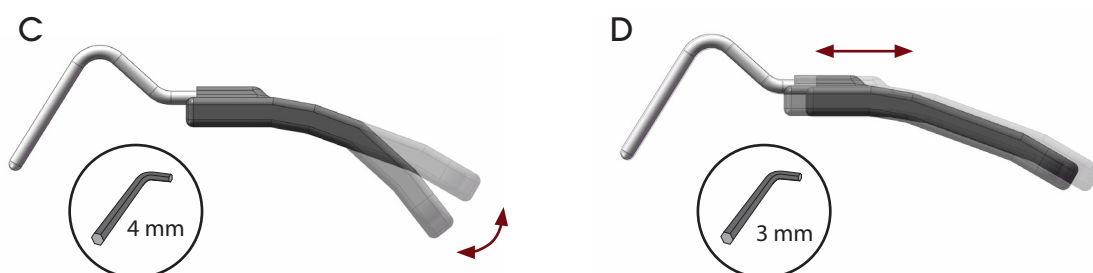

## Swing model

The thoracic supports are available in Swing models (E), which allow the pad to be swung away with the push of a button, e.g. in a transfer situation (F). The Swing support can also be set at any angle to the user's body (G). This angle is adjusted with the supplied Allen key.

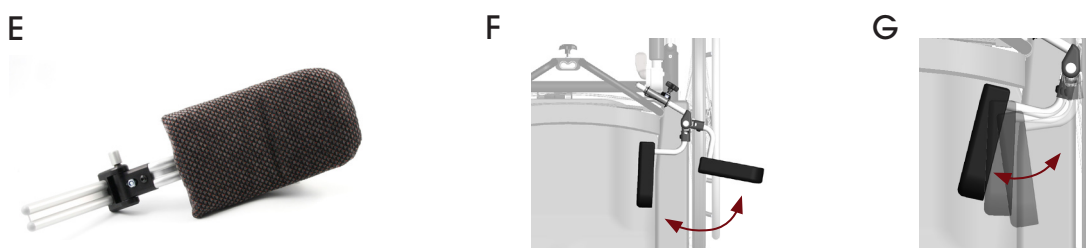

### Narrow and wide position

All thoracic supports can be adjusted in width by moving the mounting profile in its bracket. Additionally, most thoracic supports are available with a mounting profile for both narrow and wide position (H). The narrow position mounting profile is used for a person whose back is as wide as, or narrower than, the width of the wheelchair back. The wide position mounting profile is used for a person whose back is wider than the width of the wheelchair back. The narrow position mounting profile can be moved 5 cm further in as compared to the wide position mounting profile.

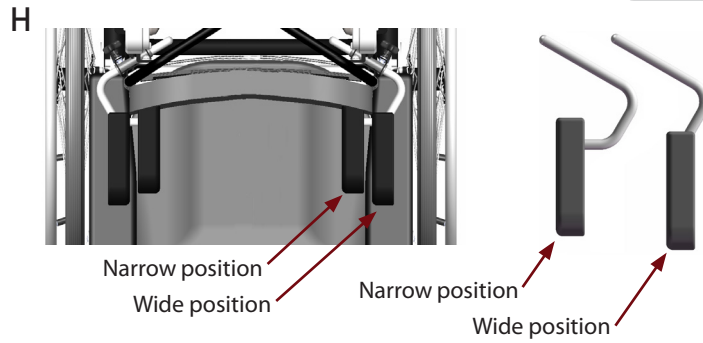

Table 1 - Versions

Model	Narrow position	Wide position
Standard	✓	✓
Adjustable short	Only one position	
Adjustable long	Only one position	
Swing - Standard	✓	✓
Swing - Adjustable short	✓	✓
Swing - Adjustable long	✓	✓

### Mounts

Mounts (I) for the thoracic supports are order separately.



### Adjustment

The thoracic supports are adjusted in height by attaching the mount using the holes in the backrest (J). The mount can then slide 3 cm in height (K). A wrench is used (10 mm).

The thoracic supports are adjusted in width by loosening the knob and sliding the bend inwards / outwards in the bracket (L).

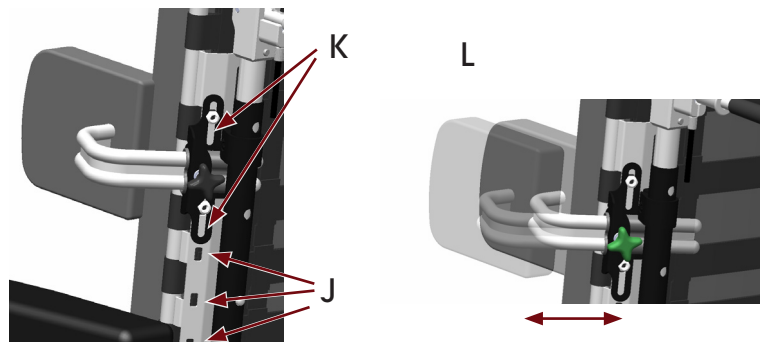

### Measurements - Pads

Table 2 - Measurements - pads

Model	height [cm]	depth [cm]	thickness [cm]
Standard	13	14	2,5
Adjustable short	13	24	3,5
Adjustable long	13	28	3,5

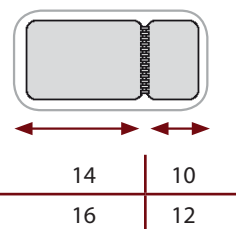

## Setting dimensions

Setting dimensions for thoracic supports, as shown in figure M, are given in Tables 3 and 4. All dimensions in cm.

**Table 3 - Distance between pads [cm]**

Seat width	Model	Narrow position		Wide position	
		<i>a</i> min	<i>a</i> max	<i>a</i> min	<i>a</i> max
54	Standard	41	51	51	60
	Adjustable	45	53	-	-
	Swing Standard	41	51	48	58
	Swing Adjustable	42	52	46	57
58	Standard	45	55	55	64
	Adjustable	49	57	-	-
	Swing Standard	45	55	52	62
	Swing Adjustable	46	56	50	61
62	Standard	49	59	59	68
	Adjustable	53	61	-	-
	Swing Standard	49	59	56	66
	Swing Adjustable	50	60	54	65

Where no measurements are given there is only one bend available for that model.

M

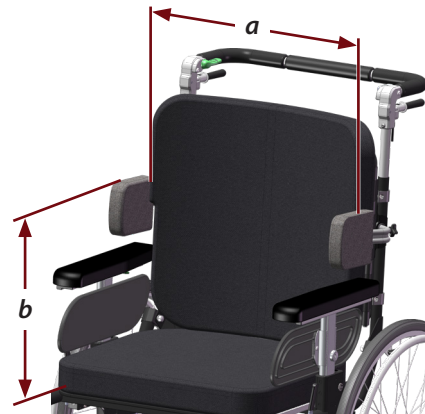

## Covers

Thoracic support pads are upholstered with black Trevira. They can also be ordered in black wipeable Dartex. The covers are removable and washable at 60° C. Covers can also be ordered separately.

## Keep in mind

- Note that the use of thoracic supports requires careful individual fitting, to get good support and to avoid pressure that can cause injury.
- Avoid placing the support near the patient's armpit as this area is generally considered to be intimate and sensitive to pressure.

## Article numbers

All article numbers are included in the Prescription Form, document number 97750-1.